



INNOVATING HOSPITALITY INTERIOR DESIGN,
PROCUREMENT & MANUFACTURING



INTERIOR DESIGN



PROCUREMENT



MANUFACTURING

ABOUT US

JM Hospitality Solutions LLC (JMHS) was founded in 2018 by Jimmy Macwan . Our company offers comprehensive hospitality management services, including in-house interior design, procurement and manufacturing. We use our industry experience, service expertise, and geographic reach to deliver FF&E projects nationwide. Our team works with clients to create stunning interiors that meet their goals, schedules, and budgets. We review project information to build a detailed and precise project scope, source the best products, and offer expert recommendations on product suitability and cost-effectiveness. Our focus on customer service, attention to detail, and unique approach set us apart in the industry.

JMHS FLOW

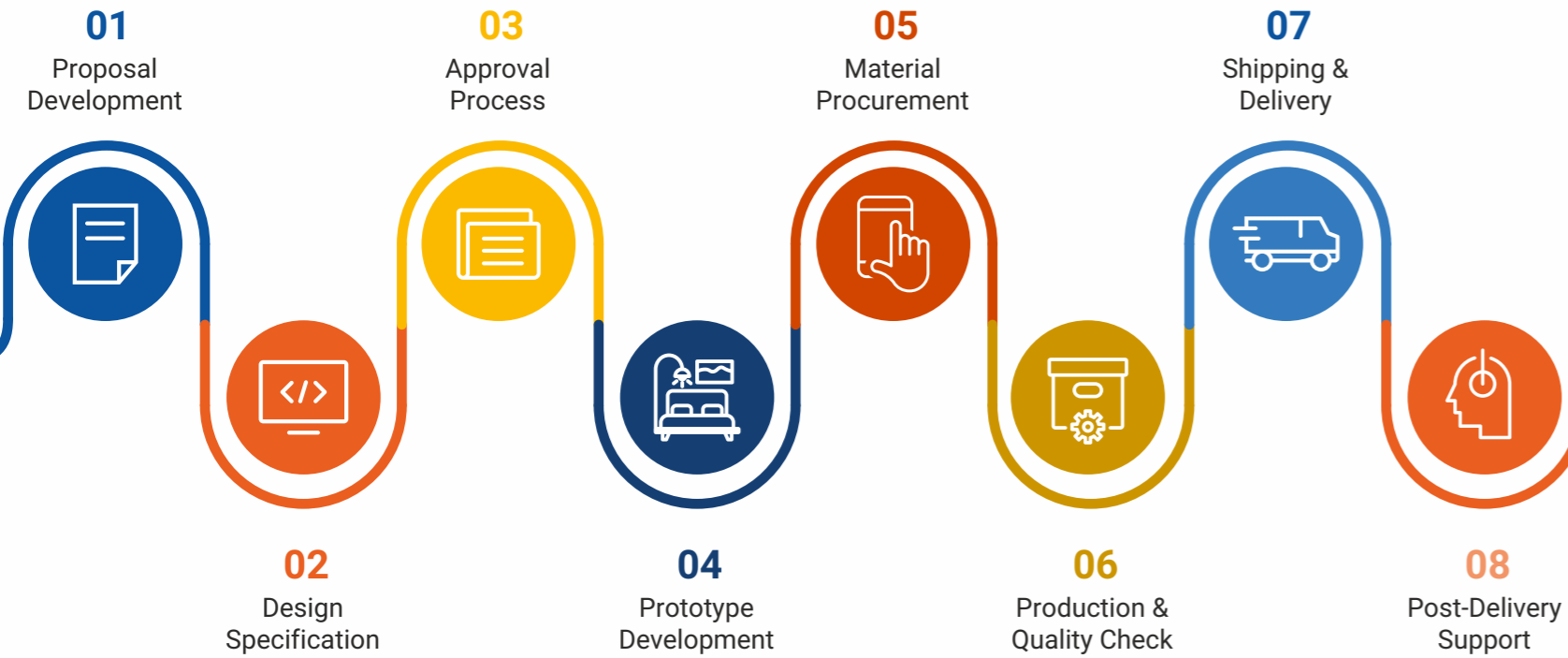

OUR SERVICES



INTERIOR DESIGN

Delivering bespoke interior design solutions that capture the essence of each client's vision, budget, and time-line since 2018.



PROCUREMENT

Leverage a vast network of suppliers and manufacturers to ensure timely and cost-effective procurement of top-quality materials and products.



MANUFACTURING

We give tailored manufacturing solutions for furniture, fixtures, and equipment that cater to our client's specific needs and preferences.

INTERIOR DESIGN SERVICES

Specification Review

JMHS offers quality while reviewing specs & budgets to identify cost-saving opportunities. We provide a detailed, itemized budget, automated cost comparisons, vendor recommendations & comprehensive reporting to keep you informed throughout the process.



Brand Submittal

We meticulously compile and organize all documentation per each brand's specific standards. We work with brand reviewers to ensure your design meets requirements and make any necessary adjustments for a successful outcome.

Renders

Our 3D models explore design styles, finishes, and influences through schematic drawings. These visual representations highlight the volumetric aspects of your design based on your selections.



INTERIOR DESIGN PROCESS



Research & Analysis

We thoroughly analyze your property and brand to ensure we understand your requirements and preferences.

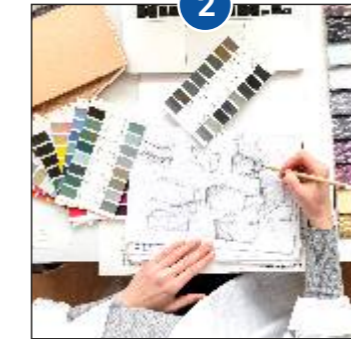

Design Development

We create a design plan incorporating your brand and design preferences while considering functionality and budget constraints.

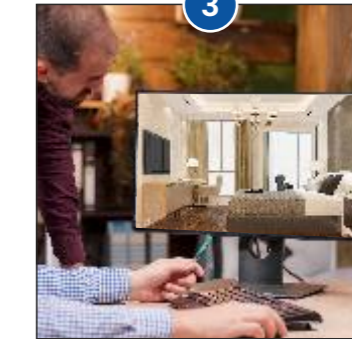

3D Rendering Images

Our team uses the latest software to produce realistic 3D rendering images of your space, allowing you to visualize the final design.



Documentation & Submittal

We produce detailed documentation of the design plan and submit it to relevant parties, ensuring that all necessary approvals are obtained before proceeding with the project.

PROCUREMENT SERVICES

Procurement Analysis

We analyze your project requirements to build a clear and concise scope while considering quality, cost, and delivery time. Our value engineering approach helps us uncover alternative options to meet your budget and goals. We leverage our vast network of suppliers and purchasing power to source the best products for your project.



Project Management

At JM Hospitality, our dedicated Project Manager oversees every aspect of the FF&E procurement process, from project scope to site installation. We prioritize effective communication to ensure a transparent and successful project. Trust us to manage your project with professionalism, expertise, and a commitment to your vision.



Bidding & Purchasing

From negotiating with suppliers to issuing purchase orders, we handle every step of the FF&E purchasing process. Our cloud-based reporting ensures transparency throughout the procurement process, and we collaborate with logistics partners to schedule cost-effective transportation and warehousing. You'll receive real-time updates to stay informed every step of the way.



PROCUREMENT PROCESS



Project Kick-Off

Collaborative planning to define project goals, objectives, and timelines.



Timeline Check

Ensuring project milestones are met on time, reducing the chance of delays.



Purchasing Management

Managing supplier relationships and issuing purchase orders and invoices.



Delivery & Installation Analysis

Assessing site readiness and coordinating delivery and installation.

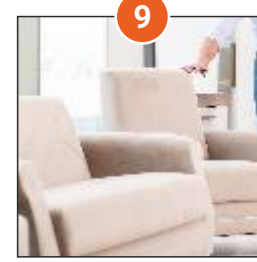

Final Inspection

A thorough review of the installation to ensure compliance with design requirements and specifications.



Comprehensive Budget Analysis

A detailed assessment of project costs and spending.

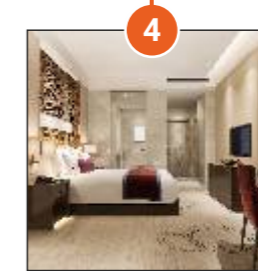

Model Room

Creating a prototype room to test design concepts and evaluate the final product.



Product Tracking & Logistics

Managing the flow of products to ensure timely delivery.



Installation Reporting

Detailed reporting ensures installation is completed according to design specifications.

MANUFACTURING SERVICES



Line Drawings

Experience accurate and detailed line drawings that capture every essential detail of your case goods, soft seating, and lighting. Our team collaborates with our overseas manufacturer to bring you the best.

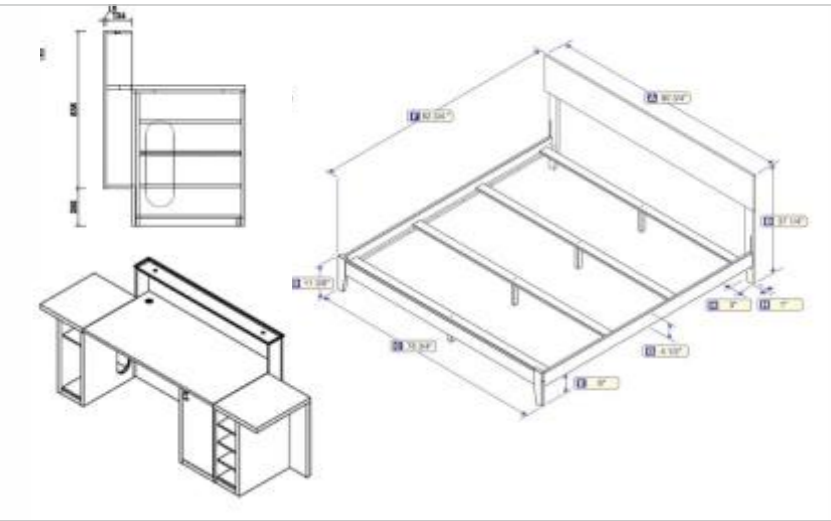

Sampling

Get a sneak peek of the final product before it's even produced. Our manufacturer creates a set of samples for your property, allowing you to make any final adjustments to ensure the perfect outcome.



Quality Assurance

We don't compromise on quality. Our logistics team works tirelessly to ensure every piece is delivered to your satisfaction. We provide detailed documentation, including production pictures and pack-slip, to guarantee quality control and give you peace of mind.

MANUFACTURING PROCESS



Collaborate with client and share pricing

We collaborate with clients and provide transparent pricing throughout the manufacturing process.



Provide detailed shop drawings

Our inhouse team provides detailed drawings to ensure accuracy and precision in the manufacturing process.

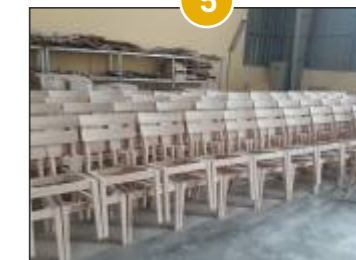

Provide progress photos of all products

Clients receive progress photos of all products to ensure quality and accuracy.



Acknowledgment & key steps & dates

We regularly update clients on critical steps and dates.



Provide JMHS standard finish samples

We provide clients with JMHS standard finish samples to ensure their vision is executed flawlessly.



QA and Delivery to the customer

We provide thorough QA and Delivery, ensuring complete product satisfaction.

MAKING CLIENTS HAPPY

We are very fortunate to have formed excellent partnerships with many of our clients. And we've formed more than just working relationships with them; we have formed true friendships. Here's what they're saying about us.



"The team at JM Hospitality was extremely professional, patient, and helpful throughout our search. They were outstanding and made one part of my job so much easier by taking the risk."

Chitan Patel
CEO & President
of Arris Hospitality



"JM Hospitality has allowed us to negotiate even better prices than we already had! In addition, they offer personal service and advice which facilitates our daily routine."

Mehul Patel
CEO & President
Magnolia Hospitality Group



"JM Hospitality is an excellent partner when it comes to purchasing. I only need to inform them about which suppliers and products I work with and they will search for the product with the right price/quality balance. It saves me."

Ketan Patel
Owner
Holiday INN Express

WHY CHOOSE JMHS

Choosing JM Hospitality Solutions means you can trust that your project will be handled with professionalism, expertise, and personalized attention. With over 10 years of experience in the hospitality industry, our team has the knowledge and skills to ensure your project is completed on time, within budget, and to the highest quality standards.

Effective communication is critical to a successful project, and we maintain a clear and transparent channel throughout the process. Our team works closely with clients to ensure that their specific needs and goals are met, and we provide regular progress updates to keep them informed every step of the way.

At JMHS, we are dedicated to providing exceptional service and exceeding our client's expectations. Choose us for your next project and experience the JMHS difference.

- **With our in-house design team we commit to quality assurance throughout the process.**
- **Value engineering approach to uncover alternative products and materials as needed to meet your budget and goals.**
- **Procurement process focussed on sourcing the best products for your project while keeping costs in mind.**
- **Detailed documentation and progress photos provided to ensure project completion to exact specifications**
- **Extensive supply chain used to source products.**
- **Experienced team dedicated to effective communication and project management.**

100+ SATISFIED CUSTOMERS

• DECADES OF INDUSTRY EXPERIENCE

• ONE STOP SOLUTION FOR ALL FF&E PRODUCTS



We're Experienced

With years of experience in the hospitality industry, we have the expertise to handle all projects, from small renovations to large-scale new construction.



We Know What We're Doing

Our team of experts deeply understands the procurement and manufacturing process, allowing us to deliver high-quality products on time and within budget.



We Speak the Same Language

At JM Hospitality Solutions, effective communication is critical to a successful project. Our team speaks your language and will work closely with you to ensure your vision is executed flawlessly.



We Fit into all Budgets

We understand that every project has unique budget constraints. Our value engineering approach allows us to offer cost-effective solutions without sacrificing quality or design.

COMPLETED PROJECTS

BEST WESTERN HOTELS & RESORTS

- BEST WESTERN - Seagoville, TX
- Best Western - Kansas City, MO
- Best Western Plus - Raleigh, NC
- Best Western Plus - Jacksonville, FL

BOUTIQUE HOTEL

- Hotel Laurel - Watkins Glen, NY

CHOICE HOTELS

- Comfort Suites - Fort Worth, TX
- Comfort Suites - Nashville, TN
- Comfort Suites - Greenville, NC
- Comfort Suites - Myrtle Beach, SC
- Comfort Suites - Lumberton, NC
- Comfort suites - Lawton, OK
- Comfort Suites - Kingsland, GA
- Comfort Inn & Suites-Bossier City, LA
- Comfort Inn & Suites DFW - Irving, TX
- Comfort Inn & Suites - Lubbock, TX
- Comfort Suites - Humble, TX
- Comfort Suites - Sanford, NC
- Comfort Suites-Main Stay – Conover, NC
- Comfort Suites-Main Stay –Hickory, NC
- Comfort Suites - Bossier City, LA
- Comfort INN - Balch Spring, TX
- Sleep Inn Mainstay - Dallas, TX
- Sleep INN - Conway, SC.
- Sleep Inn - Baton Rouge, LA
- Clarion Pointe - Wake Forest, NC
- Clarion Hotel - Fayetteville, NC
- Quality Inn & Suites-Waco, TX
- EconoLodge Havelock, NC
- EconoLodge - Morehead City, NC

HEALTHCARE FACILITY

- NovaCare Medical-East Bridgewater, MA

HILTON HOTELS & RESORTS

- DoubleTree - Fort Worth, TX GR
- DoubleTree - Westchase, TX
- Home 2 Suites - Raleigh, NC
- Tru by Hilton - DALLAS, TX
- Tru by Hilton-Wake Forest NC
- Hampton Inn & Suits- Cleburne, TX
- Hampton Inn & Suits- Albemarle, NC
- Hampton Inn & Suites- Brookhollow, TX

HYATT HOTELS

- Hyatt House - Baltimore, MD

IHG HOTELS & RESORTS

- Hotel Indigo RTP - Durham, NC
- Candlewood Suites - White Settlement, TX
- Candlewood Suites - Wake Forest, NC
- Holiday Inn Express - Kansas City, MO
- Holiday Inn - Kansas City, MO
- Holiday Inn Express - Waycross, GA
- Holiday Inn Express - Roanoke Rapids, NC
- Holiday Inn Express-Hiawassee, GA

MARRIOTT

- Four Points - Cary, NC
- Courtyard-Mt Arlington, NJ
- Residence INN - Shreveport, LA
- TownePlace Suites - Boone, NC
- TownePlace Suites - Baton Rouge, LA
- Spring Hill Suites - Durham, NC
- Fairfield Inn & Suites - Rocky Mount, NC

WYNDHAM HOTELS & RESORTS

- La Quinta - Selma, NC
- La Quinta Raleigh, NC
- La Quinta Jacksonville, FL
- Days Inn Weldon, NC
- Super 8 - Raleigh, NC
- Baymont Inn and Suites - Henderson, NC
- Baymont Inn - Kingsland, GA
- Microtel Inn and Suites - Greenville, NC
- Microtel Inn and Suites - Raleigh, NC



BRANDS WE SERVE



AND MANY MORE TO COME...



FEATURED PROJECT



SPRINGHILL SUITES

Marriott

DURHAM, NC





FEATURED PROJECT



TOWNEPLACE SUITES

Marriott

LA - Baton Rouge South





FEATURED PROJECT



LA QUINTA INN AND SUITES



SELMA, NC

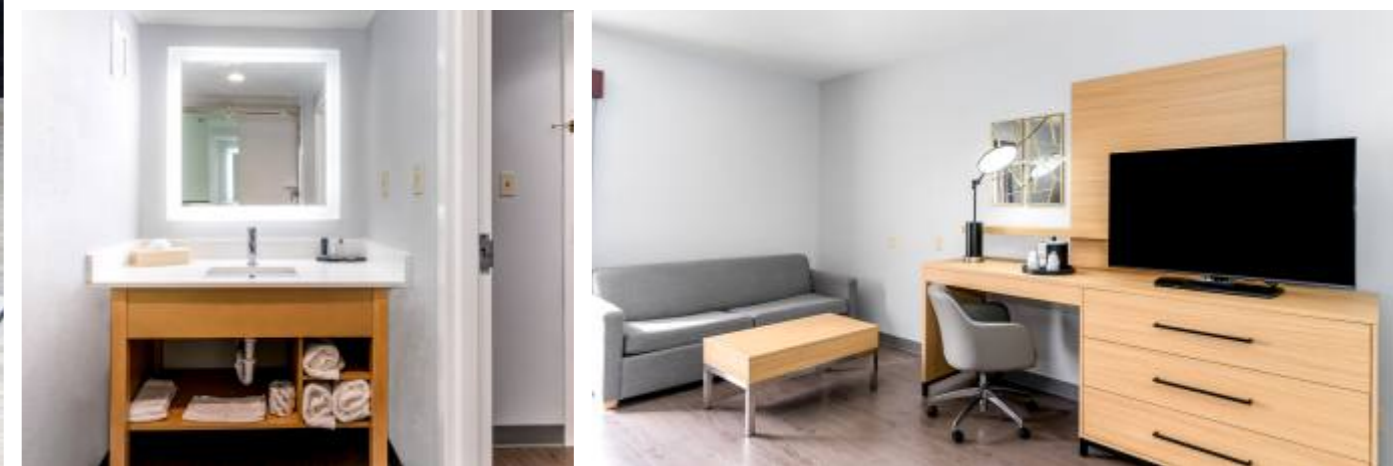

FEATURED PROJECT



HOLIDAY INN



KANSAS CITY, MO





FEATURED PROJECT



HOLIDAY INN EXPRESS



ROANOKE RAPIDS, NC

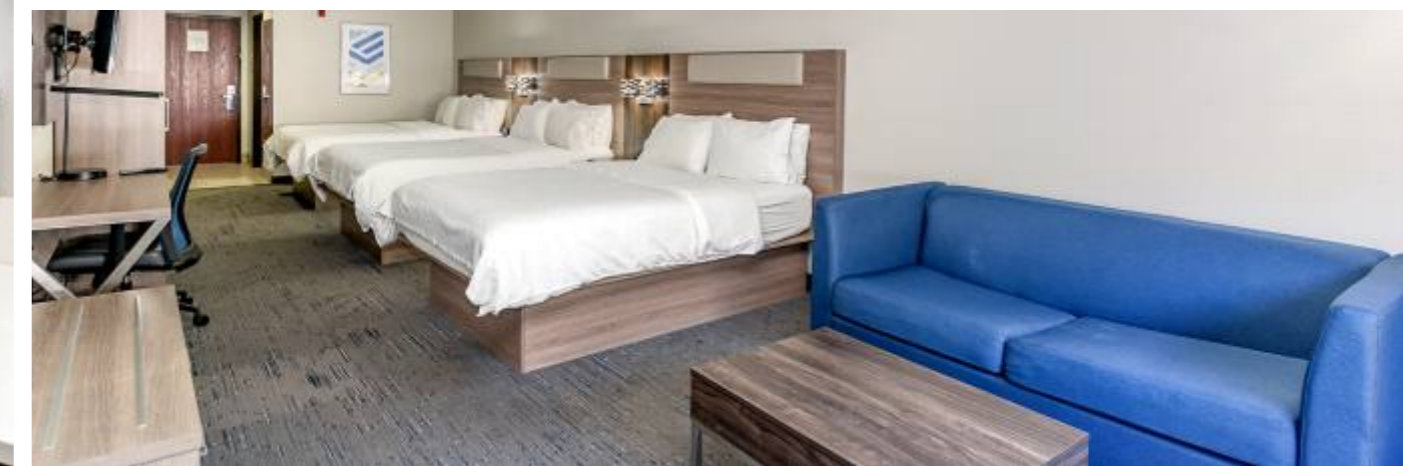



DOUBLETREE
by Hilton™

BLOOMINGTON, MN

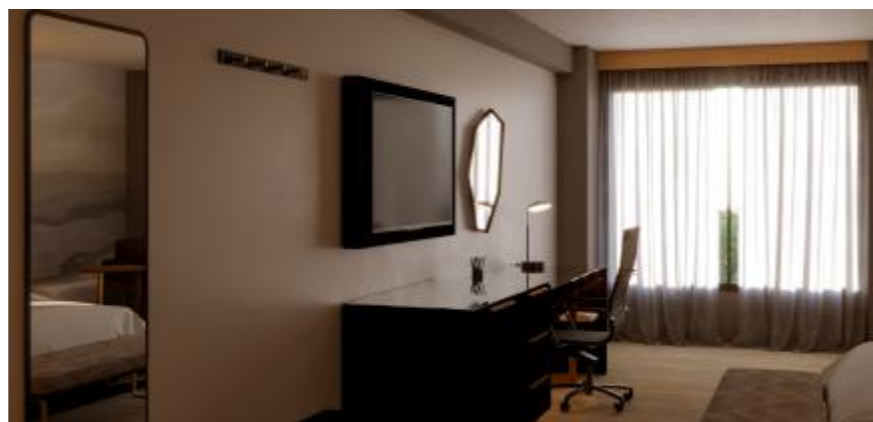



DOUBLETREE FORT WORTH, TX
by Hilton™







MORRISVILLE, NC







FEEL FREE TO CONNECT WITH 



5920 S. Miami Blvd, Suite 202

Morrisville, NC 27560

919-589-8855

info@jmhs-llc.com

www.jmhs-llc.com